

### CDK12.5 - OPTICAL TRAIN: for SBIG STX BODY, AND MMOAG

Distance to Focuser Mounting Surface 10.445

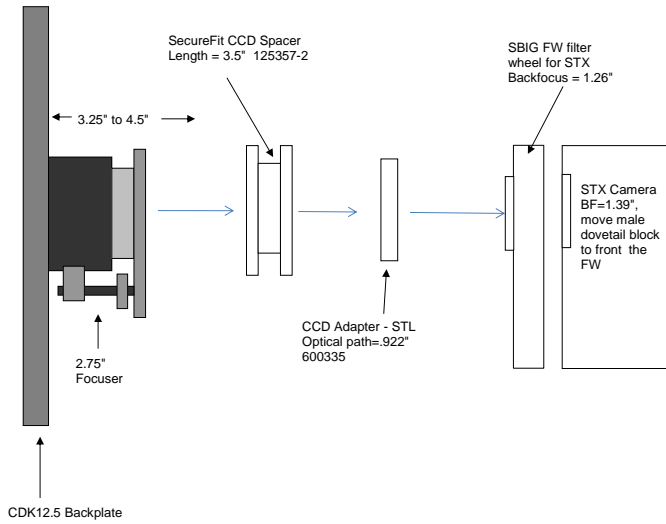

STX and FW	10.445 remaining BF	
2.75" Focuser (racked in)	3.25	7.195
Focus position (0 to 1.3")	0.123	7.072
SecureFit CCD Spacer - 125357-2	3.5	3.572
CCD Adapter -STL - 600335	0.922	2.65
SBIG FW STX (w/threaded adapter ring attached)	1.26	1.39
STX Camera	1.39	0

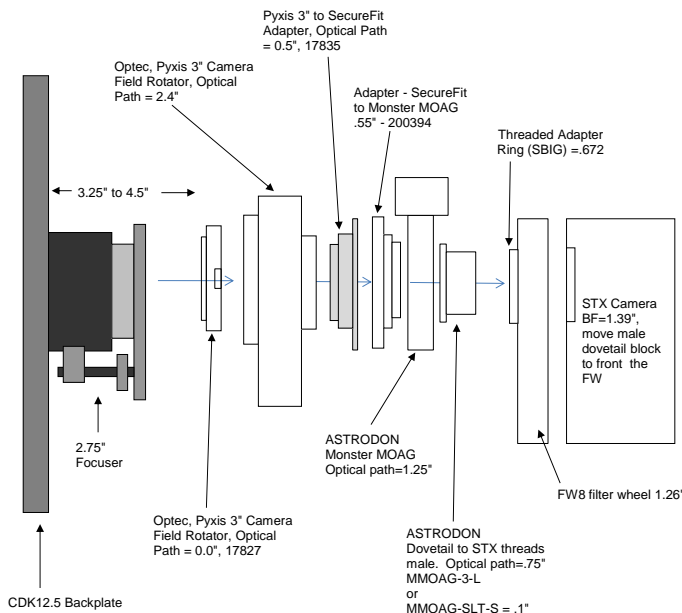

STX CCD, Pyxis & MMOAG	10.445 remaining BF	
2.75" Focuser (racked in)	3.25	7.195
Focus position (0 to 1.3")	0.34	6.855
PW 12.5 to Optec-3600 dovetail adapter - 17827	0	6.855
Optec Pyxis 3" Camera Rotator	2.4	4.455
Optec Pyxis 3" to SecureFit Adapter - 17835	0.5	3.955
Adapter SecureFit to Monster MOAG - 200394	0.55	3.405
Monster MOAG - MMOAG	1.25	2.155
AstroDon Adapter - MMOAG-SLT-S	0.1	2.055
SBIG STX Camera with mounting block	2.06	0.00

**Does not reach focus without the use of custom adapters**

STX CCD, FW8, Pyxis & MMOAG	10.445 remaining BF	
2.75" Focuser (racked in)	3.25	7.195
Focus position (0 to 1.3")	0	7.195
PW 12.5 to Optec-3600 dovetail adapter - 17827	0	7.195
Optec Pyxis 3" Camera Rotator	2.4	4.795
Optec Pyxis 3" to SecureFit Adapter - 17835	0.5	4.295
Adapter SecureFit to Monster MOAG - 200394	0.55	3.745
Monster MOAG - MMOAG	1.25	2.495
AstroDon Adapter - MMOAG-SLT-S	0.1	2.395
SBIG FW8 Filter Wheel w/threaded adapter ring attached	1.93	0.465
SBIG STX Camera	1.39	-0.925

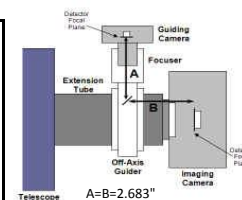
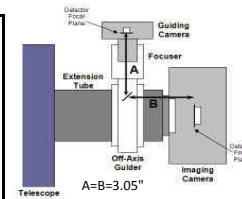

**PLANEWAVE INSTRUMENTS**  
CDK12 SPACERS FOR STX CAMERAS

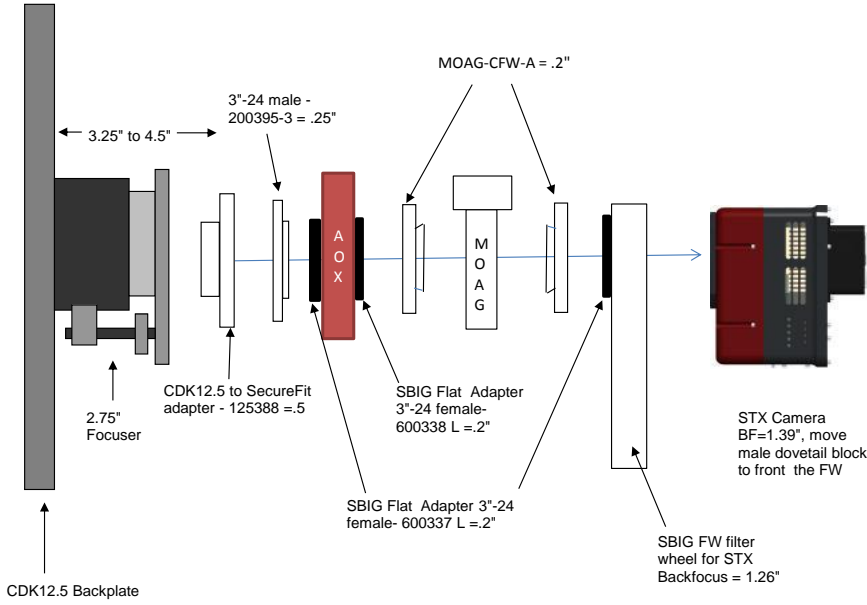

STX camera and MMOAG		10.45 remaining BF
Hedrick Focuser, 2.75"	3.25	7.2
Focuser position (0-1.3")	<b>0.37</b>	6.83
CDK12.5 to SecureFit - 125388	0.5	6.33
SecureFit to 3"-24 male - 200395-3	0.25	6.08
SBIG Flat Adapter (3"-24 female) - 600337	0.2	5.88
AO-X	1.18	4.7
SBIG Flat Adapter (3"-24 female) - 600338	0.2	4.5
MOAG-CWF-A	0.2	4.3
AstroDon part - MMOAG	1.25	3.05
MOAG-CWF-A	0.2	2.85
SBIG Flat Adapter (3"-24 female) - 600337	0.2	2.65
Filter Wheel, FW8	1.26	1.39
SLX Back Focus	1.39	0

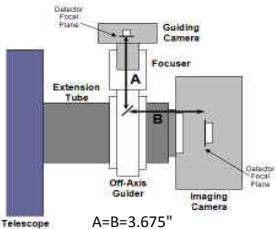

PLANEWAVE INSTRUMENTS  
CDK12.5 SPACERS FOR STXL CAMERAS

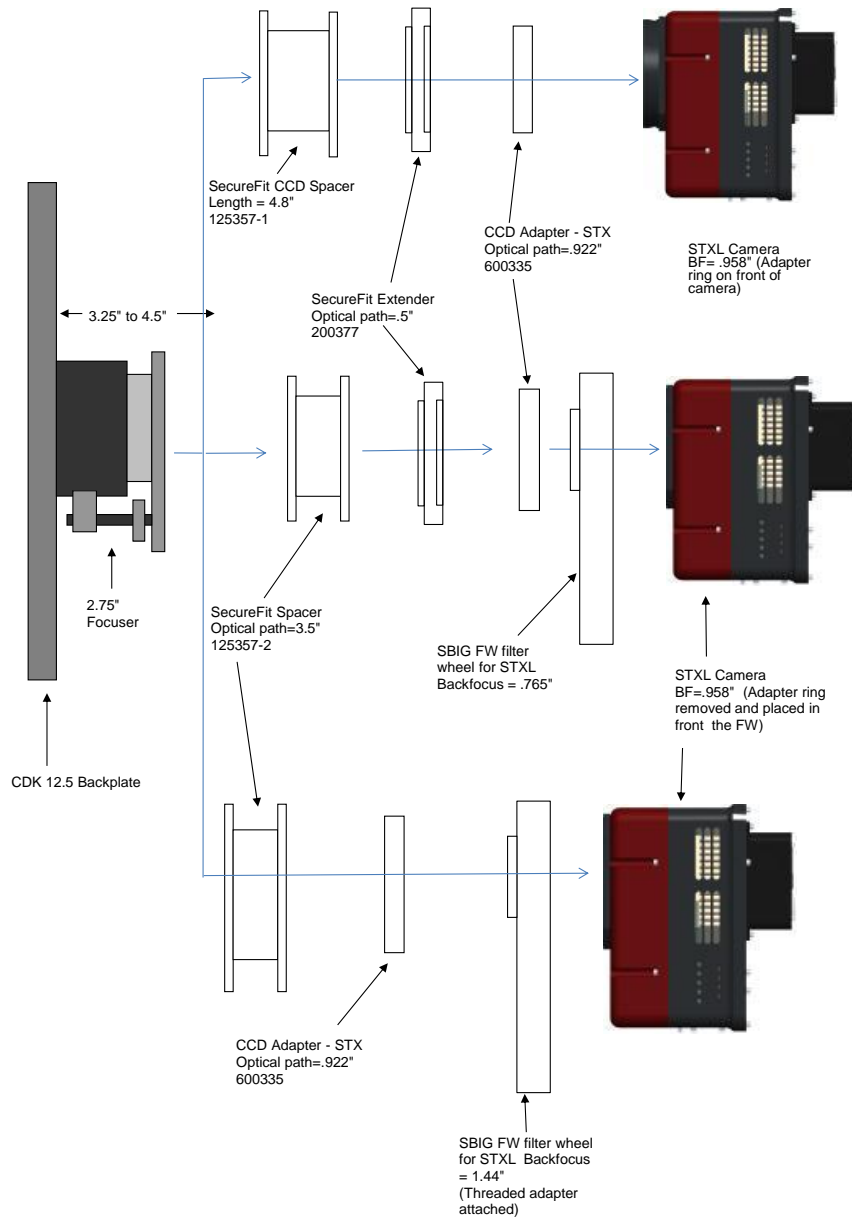

STXL		
	10.445	remaining BF
Focuser racked in	3.25	7.195
Focuser position (0-1.3")	0.815	6.38
CCD Spacer 4.8" - 125357-2	3.5	2.88
SecureFit Extender - 200377	0.5	2.38
SecureFit Extender - 200377	0.5	1.88
CCD Adapter STX - 600335	0.922	0.958
STXL Back Focus (w/Threaded Adapter attached)	0.958	0

STXL w/ Standard FW		
	10.445	remaining BF
Focuser racked in	3.25	7.195
Focuser position (0-1.3")	0.55	6.645
SecureFit CCD Spacer - 125357-2	3.5	3.145
SecureFit Extender - 200377	0.5	2.645
CCD Adapter STX - 600335	0.922	1.723
Filter Wheel (w/Threaded Adapter Ring attached)	0.765	0.958
STXL Back Focus	0.958	0

STXL w/ Self Guiding FW		
	10.445	remaining BF
Focuser racked in	3.25	7.195
Focuser position (0-1.3")	0.375	6.82
SecureFit CCD Spacer - 125357-2	3.5	3.32
CCD Adapter STX - 600335	0.922	2.398
Filter Wheel, Self Guiding w/threaded adapter ring attached	1.44	0.958
STXL Back Focus	0.958	0

PLANEWAVE INSTRUMENTS  
SECUREFIT CCD SPACERS FOR ST CAMERAS  
for CDK12.5

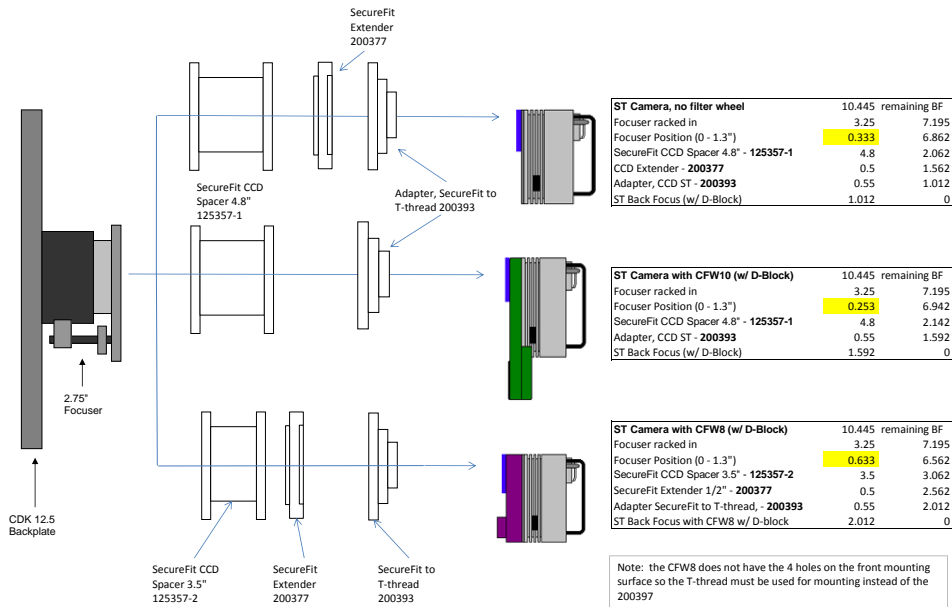

PLANEWAVE INSTRUMENTS  
SECUREFIT CCD SPACERS FOR ST CAMERAS  
for CDK12.5

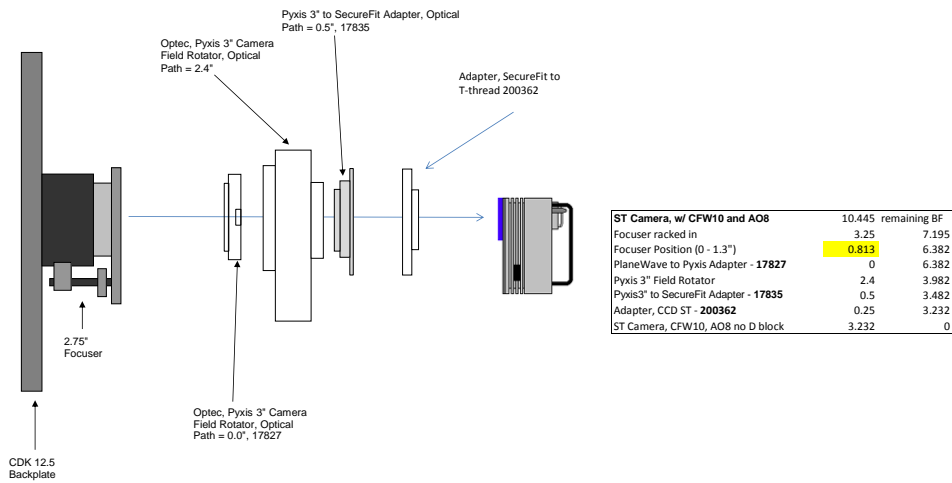

**PLANEWAVE INSTRUMENTS**  
**2" CCD SPACERS FOR ST CAMERAS**  
for CDK12.5

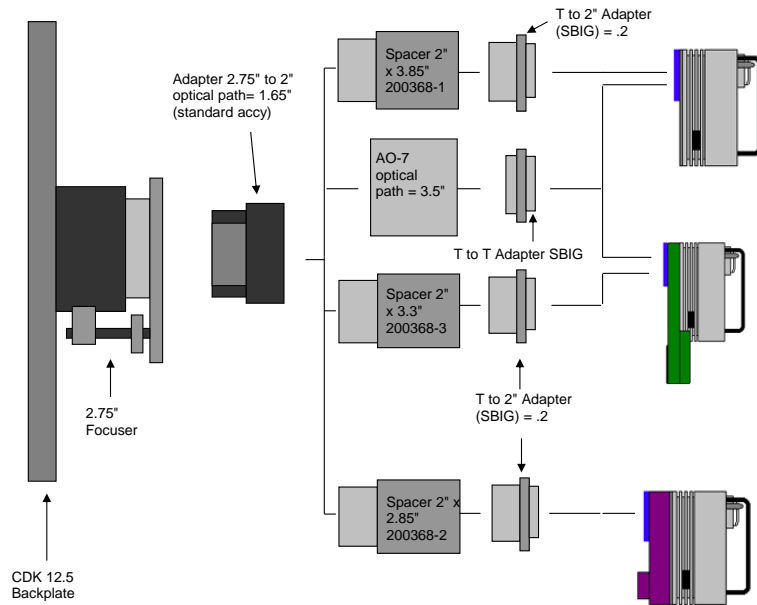

<b>ST Camera, no filter wheel</b>		10.445 remaining BF
Focuser racked in	3.25	7.195
Focuser Position (0 - 1.3")	<b>0.483</b>	6.712
Adapter, 2.75 to 2 (standard accy)	1.65	5.062
CCD 2" SPACER x 3.85" - <b>200368-1</b>	3.85	1.212
T to 2 Adapter (SBIG)	0.2	1.012
ST Back Focus (with D-Block)	1.012	0

<b>ST Camera + AO-7</b>		10.445 remaining BF
Focuser racked in	3.25	7.195
Focuser Position (0 - 1.3")	<b>0.835</b>	6.36
Adapter, 2.75 to 2 (standard accy)	1.65	4.71
T to T Adapter (SBIG)	0.2	4.51
ST + AO-7 backfocus	4.51	0

<b>ST Camera with CFW10 w/ D-Block</b>		10.445 remaining BF
Focuser racked in	3.25	7.195
Focuser Position (0 - 1.3")	<b>0.453</b>	6.742
Adapter, 2.75 to 2 (standard accy)	1.65	5.092
CCD 2" SPACER x 3.3" - <b>200368-3</b>	3.3	1.792
T to 2 Adapter (SBIG)	0.2	1.592
ST Back Focus (with D-Block)	1.592	0

<b>ST + CFW10 + AO-7</b>		10.445 remaining BF
Focuser racked in	3.25	7.195
Focuser Position (0 - 1.3")	<b>0.255</b>	6.94
Adapter, 2.75 to 2 (standard accy)	1.65	5.29
T to T Adapter (SBIG)	0.2	5.09
ST + AO-7 backfocus	5.09	0

<b>ST Camera with CFW8 w/ D-Block</b>		10.445 remaining BF
Focuser racked in	3.25	7.195
Focuser Position (0 - 1.3")	<b>0.483</b>	6.712
Adapter, 2.75 to 2 (standard accy)	1.65	5.062
CCD 2" SPACER x 2.85" - <b>200368-2</b>	2.85	2.212
T to 2 Adapter (SBIG)	0.2	2.012
ST Back Focus (with D-block)	2.012	0

**DOES NOT HAVE ENOUGH BACK FOCUS**

<b>ST + CFW8 + AO-7</b>		10.445 remaining BF
Focuser racked in	3.25	7.195
Focuser Position (0 - 1.3")	<b>0</b>	7.195
Adapter, 2.75 to 2 (standard accy)	1.65	5.545
T to 2 Adapter (SBIG)	0.2	5.345
ST + AO-7 backfocus	5.51	<b>-0.165</b>

**PLANEWAVE INSTRUMENTS**  
CDK12.5 SECUREFIT SPACERS FOR STT CAMERAS

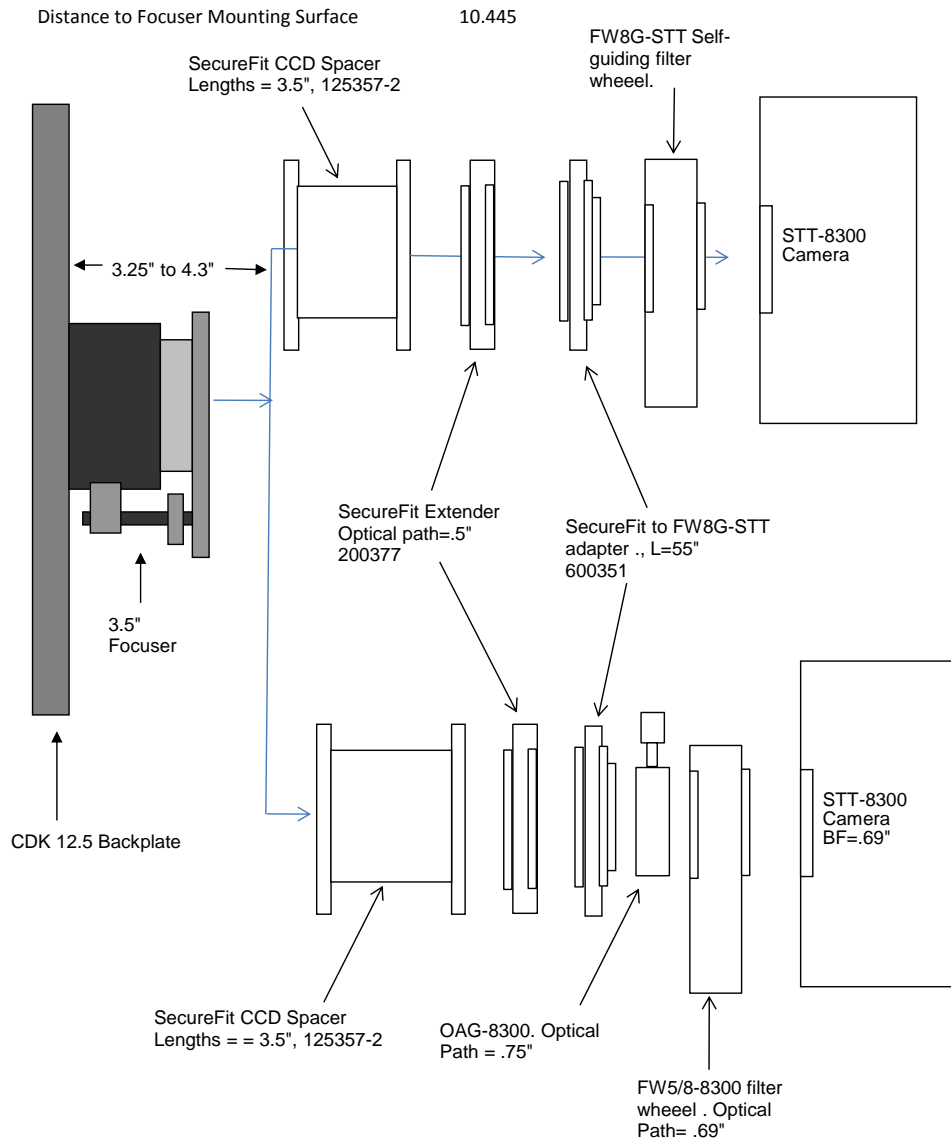

<b>STT8300 Camera w/ Self Guiding Filter Wheel</b>	10.445	remaining BF
Focuser racked in	3.25	7.195
Focuser position (0-1.3")	0.517	6.678
SecureFit Spacer 3.5- <b>125357-2</b>	3.5	3.178
CCD SecureFit Extender - <b>200377</b>	0.5	2.678
SecureFit to FW8G-STT - <b>600351</b>	0.55	2.128
FW8G-SST attached to STT-8300 Camera	2.128	0

<b>STT8300 Camera w/Filter Wheel, OAG8300</b>	10.445	remaining BF
Focuser racked in	3.25	7.195
Focuser position (0-1.3")	0.415	6.78
SecureFit Spacer 3.5- <b>125357-2</b>	3.5	3.28
CCD SecureFit Extender - <b>200377</b>	0.5	2.78
SecureFit to FW8G-STT - <b>600351</b>	0.55	2.23
OAG-8300	0.75	1.48
FW5-8300 / FW8-8300	0.79	0.69
STT-8300 Camera	0.69	0

**PLANEWAVE INSTRUMENTS**  
**SECUREFIT CCD SPACERS FOR STL CAMERAS**  
 for CDK12.5

← 10.445 →  
 Distance from focuser mounting surface to focal plane

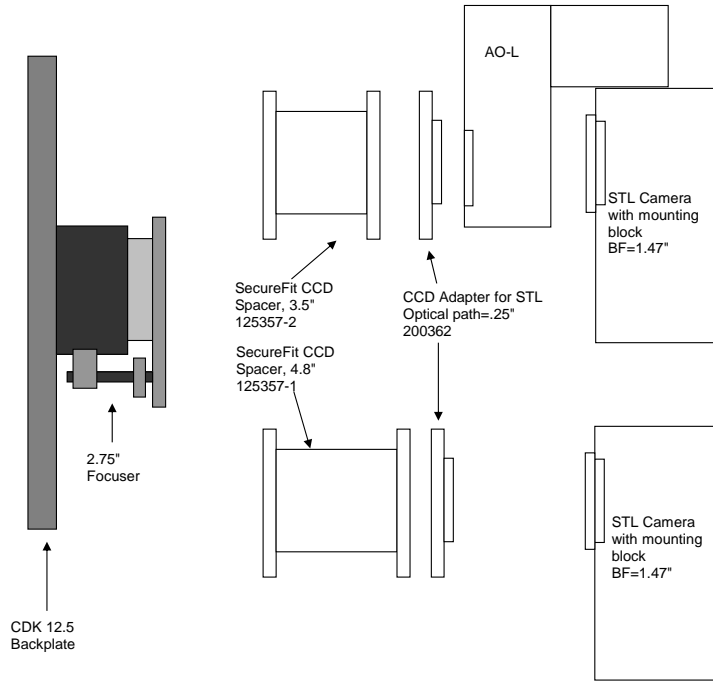

STL and AO-L required spacers	10.445 remaining BF	
2.75" Focuser (racked in)	3.25	7.195
Focus position (0 to 1.3")	0.485	6.71
SecureFit CCD Spacer 3.5" - 125357-2	3.5	3.21
CCD Adapter, STL - 200362	0.25	2.96
AO-L	1.49	1.47
STL Back Focus	1.47	0

STL Camera	10.445 remaining BF	
2.75" Focuser (racked in)	3.25	7.195
Focus position (0 to 1.3")	0.675	6.52
SecureFit CCD Spacer 4.8" - 125357-1	4.8	1.72
CCD Adapter, STL - 200362	0.25	1.47
STL Back Focus	1.47	0

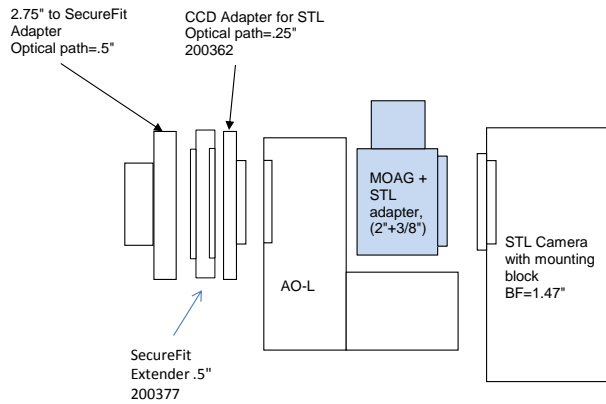

STL, AO-L and MOAG	10.445 remaining BF	
2.75" Focuser (racked in)	3.25	7.195
Focus position (0 to 1.3")	0	7.195
2.75" to SecureFit	0.5	6.695
SecureFit Extender - 200377	0.5	6.195
CCD Adapter, STL - 200362	0.25	5.945
AO-L	1.49	4.455
MOAG from Astrodon (2" of backfocus)	2	2.455
MOAG to SLT Adapter (3/8")	0.375	2.08
STL Back Focus	1.509	0.571

**PLANEWAVE INSTRUMENTS**  
**SECUREFIT CCD SPACERS FOR STL CAMERAS**  
for CDK12.5

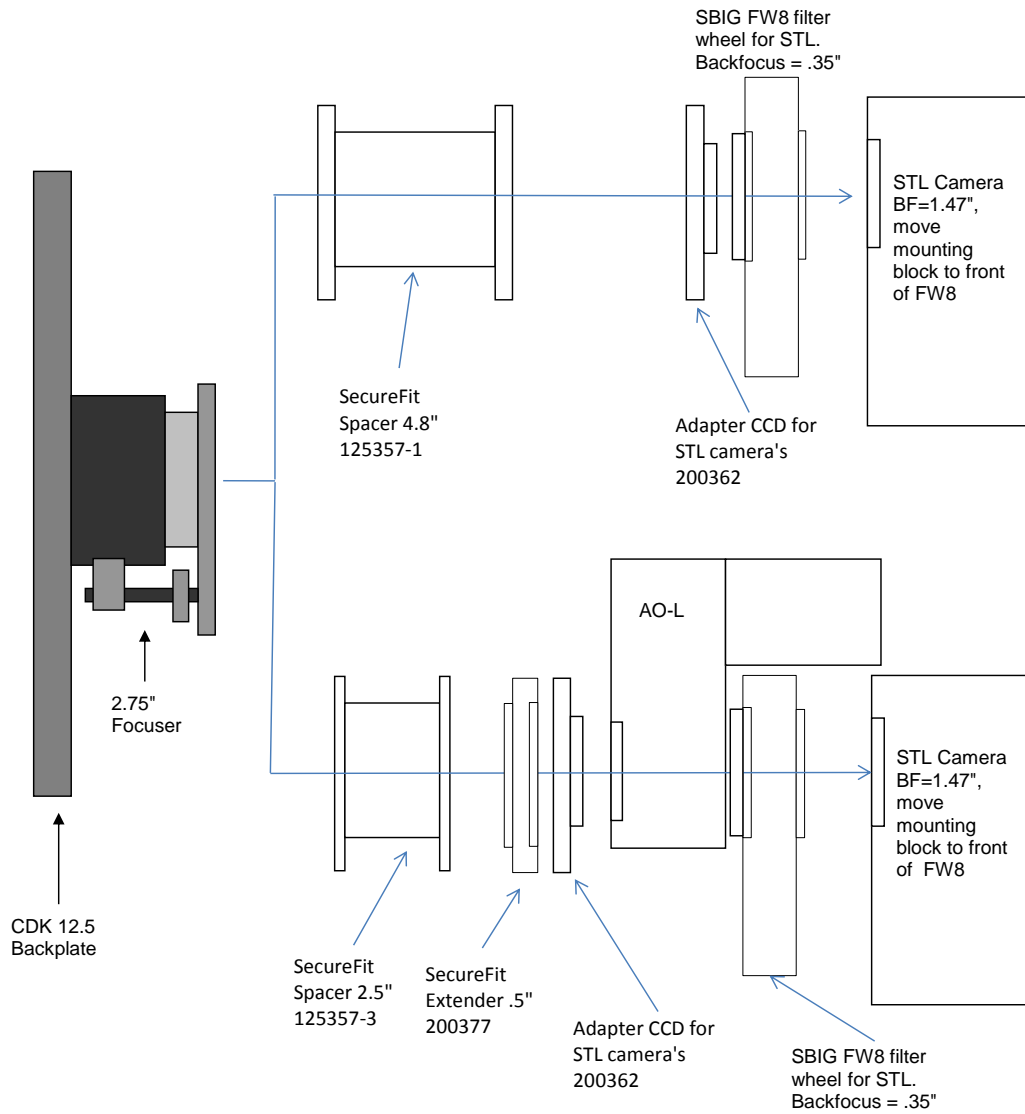

STL w/ FW8	10.445	remaining BF
Focuser racked in	3.25	7.195
Focus position (0 to 1.3")	0.325	6.87
SecureFit CCD Spacer 4.8" - <b>125357-1</b>	<b>4.8</b>	2.07
CCD Adapter, STL - <b>200362</b>	0.25	1.82
FW8	0.35	1.47
SLT Back Focus	1.47	0

STL + FW8 + AO-L	10.445	remaining BF
Focuser racked in	3.25	7.195
Focus position (0 to 1.3")	0.635	6.56
SecureFit CCD Spacer 2.5" - <b>125357-3</b>	<b>2.5</b>	4.06
SecureFit CCD Extender .5" - <b>200377</b>	0.5	3.56
CCD Adapter, STL - <b>200362</b>	0.25	3.31
AO-L	1.49	1.82
FW8	0.35	1.47
SLT Back Focus	1.47	0



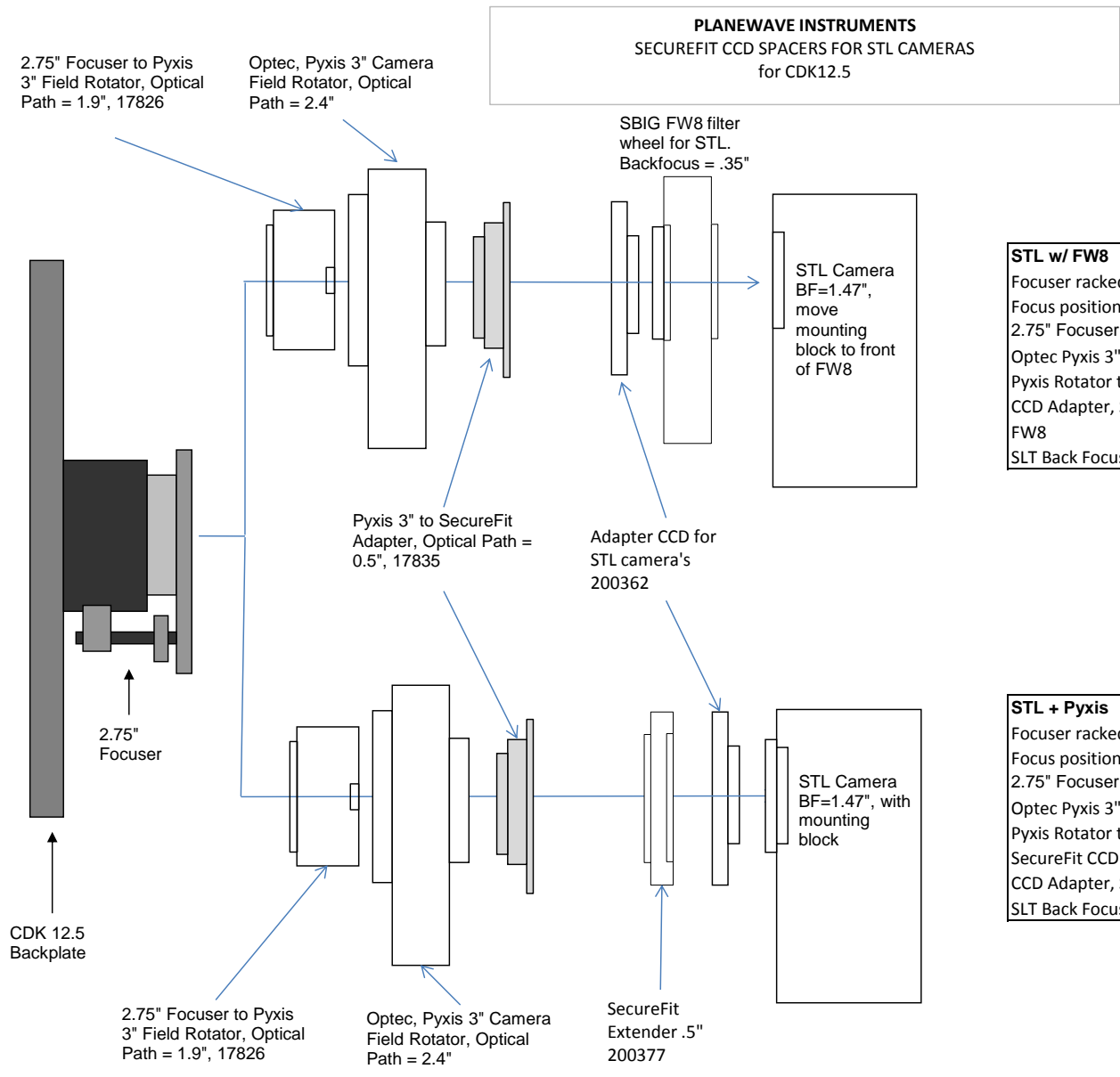

STL w/ FW8	10.445 remaining BF	
Focuser racked in	3.25	7.195
Focus position (0 to 1.3")	0.325	6.87
2.75" Focuser to Pyxis Rotator - <b>17826</b>	1.9	4.97
Optec Pyxis 3" Rotator - <b>PYXIS 3</b>	2.4	2.57
Pyxis Rotator to SecureFit - <b>17835</b>	0.5	2.07
CCD Adapter, STL - <b>200362</b>	0.25	1.82
FW8	0.35	1.47
SLT Back Focus	1.47	0

STL + Pyxis	10.445 remaining BF	
Focuser racked in	3.25	7.195
Focus position (0 to 1.3")	0.175	7.02
2.75" Focuser to Pyxis Rotator - <b>17826</b>	1.9	5.12
Optec Pyxis 3" Rotator - <b>PYXIS 3</b>	2.4	2.72
Pyxis Rotator to SecureFit - <b>17835</b>	0.5	2.22
SecureFit CCD Extender .5" - <b>200377</b>	<b>0.5</b>	1.72
CCD Adapter, STL - <b>200362</b>	0.25	1.47
SLT Back Focus	1.47	0

### CDK12.5 - OPTICAL TRAIN: for SBIG STL BODY, AND MMOAG

Distance to Focuser Mounting Surface 10.445

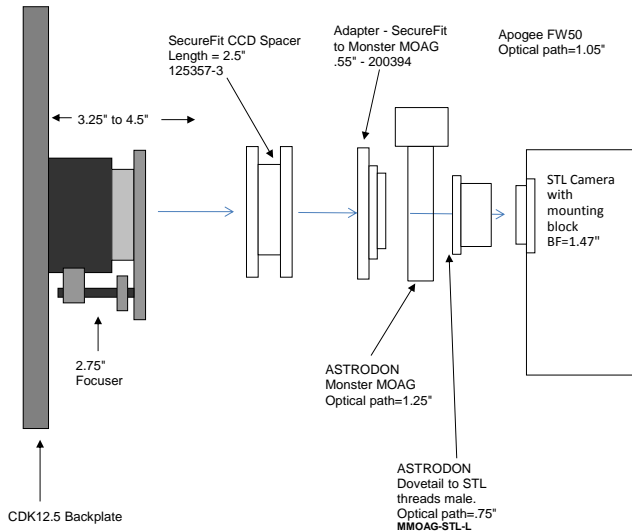

STL CCD & MMOAG		
2.75" Focuser (racked in)	3.25	7.195
SecureFit CCD Spacer - 125357-3	2.5	4.02
Adapter SecureFit to Monster MOAG - 200394	0.55	3.47
Monster MOAG - MMOAG	1.25	2.22
AstroDon Adapter - MMOAG-STL-L	0.75	1.47
SBIG STL Camera with mounting block	1.47	0
<b>Focus position (0 to 1.3")</b>	<b>0.675</b>	6.52
10.445 remaining BF		

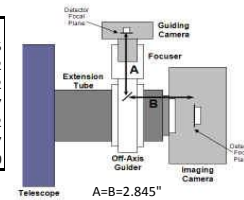

STL CCD, FW8 FILTER WHEEL & MMOAG		
2.75" Focuser (racked in)	3.25	7.195
SecureFit CCD Spacer - 125357-3	2.5	4.22
Adapter SecureFit to Monster MOAG - 200394	0.55	3.67
SecureFit Spacer 0.5" - 200377	0.5	3.17
Monster MOAG - MMOAG	1.25	1.92
AstroDon Adapter - MMOAG-STL-S	0.1	1.82
SBIG FW8 Filter Wheel	0.35	1.47
SBIG STL Camera with mounting block	1.47	0
<b>Focus position (0 to 1.3")</b>	<b>0.475</b>	6.72
10.445 remaining BF		

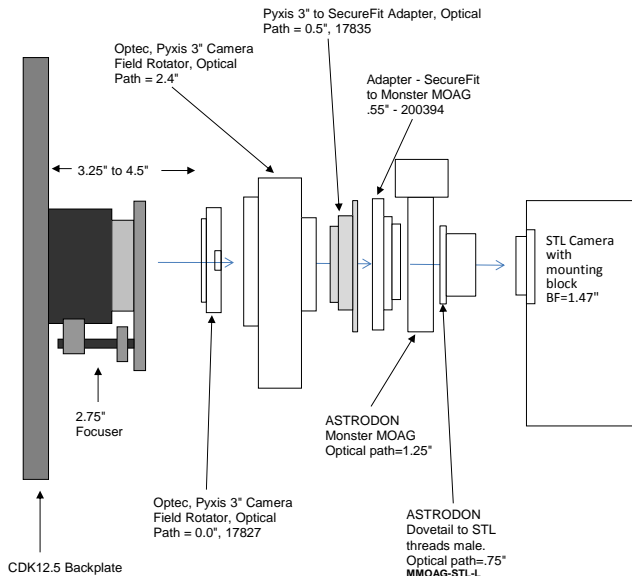
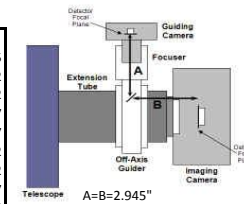

STL CCD, Pyxis & MMOAG		
2.75" Focuser (racked in)	3.25	7.195
PW 12.5 to Optec-3600 dovetail adapter - 17827	0	6.92
Optec Pyxis 3" Camera Rotator	2.4	4.52
Optec Pyxis 3" to SecureFit Adapter - 17835	0.5	4.02
Adapter SecureFit to Monster MOAG - 200394	0.55	3.47
Monster MOAG - MMOAG	1.25	2.22
AstroDon Adapter - MMOAG-STL-L	0.75	1.47
SBIG STL Camera with mounting block	1.47	0
<b>Focus position (0 to 1.3")</b>	<b>0.275</b>	6.92
10.445 remaining BF		

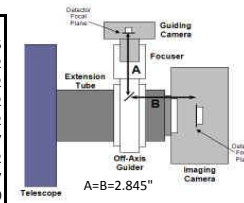

STL CCD, FW8, Pyxis & MMOAG		
2.75" Focuser (racked in)	3.25	7.195
PW 12.5 to Optec-3600 dovetail adapter - 17827	0	6.62
Optec Pyxis 3" Camera Rotator	2.4	4.22
Optec Pyxis 3" to SecureFit Adapter - 17835	0.5	3.72
Adapter SecureFit to Monster MOAG - 200394	0.55	3.17
Monster MOAG - MMOAG	1.25	1.92
AstroDon Adapter - MMOAG-STL-S	0.1	1.82
SBIG FW8 Filter Wheel	0.35	1.47
SBIG STL Camera with mounting block	1.47	0
<b>Focus position (0 to 1.3")</b>	<b>0.575</b>	6.62
10.445 remaining BF		

